

MAX

Join the GoPro Movement



facebook.com/GoPro



youtube.com/GoPro



twitter.com/GoPro



instagram.com/GoPro

Contents

Meet MAX	6
Setting Up Your Camera	8
Getting to Know Your GoPro	13
HERO Mode + 360 Mode	18
Changing Modes + Settings	22
On-Screen Shortcuts	25
Using QuikCapture	28
Adding HiLight Tags	31
Setting the Screen Orientation	32
Recording Video	33
Video Settings	36
Taking Photos	38
Photo Settings	42
Capturing Time Lapse	43
Time Lapse Settings	45
Live Streaming	47
Exposure Control	48
Controlling Your GoPro With Your Voice	51
Playing Back Your Media	55

Contents

Connecting to Other Devices	59
Transferring Your Media	61
Customizing Your GoPro	66
Important Messages	75
Resetting Your Camera	77
Mounting Your GoPro	79
Removing the Door	84
Maintenance	86
Battery Information	88
Troubleshooting	91
Tech Specs: Video	92
Tech Specs: Photo	97
Tech Specs: Time Lapse	98
Tech Specs: Protune	101
Customer Support	112
Trademarks	112
Regulatory Information	112

Meet MAX

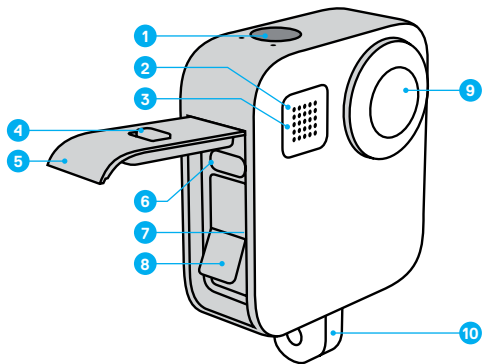

- | | |
|---|-----------------------|
| 1. Shutter Button  | 5. Door |
| 2. Status Light | 6. USB-C Port |
| 3. Microphone | 7. microSD™ Card Slot |
| 4. Door Lock | 8. Battery |

Meet MAX

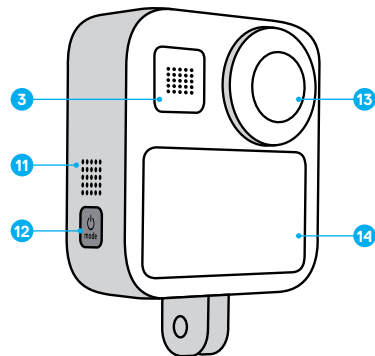

- | | |
|---------------------|---|
| 9. Camera Lens | 12. Mode Button  |
| (Non-Screen Side) | 13. Camera Lens |
| 10. Folding Fingers | (Screen Side) |
| 11. Speaker | 14. Touch Screen |

Learn how to use the accessories that came with your GoPro. See [Mounting Your GoPro](#) (page 79).

Setting Up Your Camera

MICROSD CARDS

You'll need a microSD card (sold separately) to save your videos and photos. Use a brand-name card that fits these requirements:

- microSD, microSDHC™, or microSDXC™
- Class 10 or UHS-I rating
- Capacity up to 256GB

For a list of recommended microSD cards, visit gopro.com/microsdcards.

Heads Up: Be sure your hands are clean and dry before handling your SD card. Check the manufacturer's guidelines to see your card's acceptable temperature range and other important information.

PRO TIP: Keep your SD card in good condition by reformatting it regularly. This will erase all of your media, so be sure to save it first.

1. Swipe down to access the Dashboard.
2. Tap Preferences > Reset > Format SD Card.

To learn how to save your videos and photos, see [Transferring Your Media](#) (page 61).

RECHARGEABLE BATTERY

For the best performance, be sure to use a MAX Rechargeable Battery with your new GoPro.

PRO TIP: There's an easy way to check your battery's condition.

1. Swipe down to access the Dashboard.
2. Tap Preferences > About > Battery Info.

Setting Up Your Camera

MICROSD CARD + BATTERY SETUP

1. Unlock the door, slide it down, and flip it open.



2. With your camera off, insert the SD card into the card slot with the label facing the battery compartment.

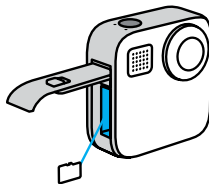

You can eject the card by pressing it into the slot with your fingernail.

Setting Up Your Camera

3. Insert the battery.

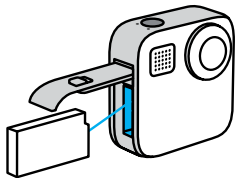

4. Connect your camera to a USB charger or computer using the included USB-C cable.

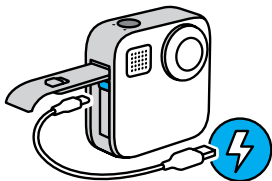

It takes about 3 hours for the battery to fully charge. The camera status light will turn off when it's done. To learn more, see [Battery Information](#) (page 88).

PRO TIP: For the fastest charging, use the GoPro Supercharger (sold separately).

Setting Up Your Camera

5. Unplug the cable and shut the door when charging's complete.



6. Slide the door all the way up until there's no gap, and then lock it.

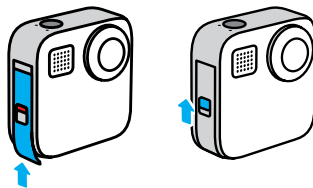

NOTICE: Push from the bottom to make sure that the door is closed correctly. Don't use the lock to slide the door closed.

Setting Up Your Camera

UPDATING YOUR CAMERA'S SOFTWARE

To get the latest features and best performance from your GoPro, make sure it's using the most current software.

Updating With the GoPro App

1. Download the app from the Apple® App Store® or Google Play™.
2. Follow the app's on-screen instructions to connect your camera to your mobile device. If new camera software is available, the app will tell you how to install it.

Updating Manually

1. Visit gopro.com/update.
2. Choose *MAX* from the list of cameras.
3. Select *Update your camera manually* and follow the instructions.

PRO TIP: Need to know your camera name, password, and software version? Here's where you can find out.

1. Swipe down to access the Dashboard.
2. Tap Preferences > Connections > Camera Info.

Heads Up: Scroll down to see the software version.

Getting to Know Your GoPro

POWERING ON

Press the Mode button  to turn on MAX.

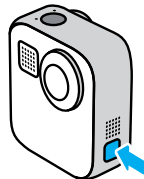

POWERING OFF

Press and hold the Mode button  for 3 seconds to turn it off.

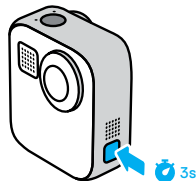

WARNING: Use caution when using your GoPro and related mounts and accessories. Always be aware of your surroundings to avoid injuring yourself and others.

Be sure to follow all local laws including all privacy laws, which may restrict recording in certain areas.

Getting to Know Your GoPro

USING THE TOUCH SCREEN



Tap

Selects an item and turns a setting on or off.

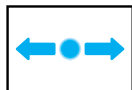

Swipe Left or Right

Switch between Video, Photo, and Time Lapse modes.



Swipe Down From the Edge of the Screen

Open the Dashboard when your camera is in a landscape orientation.



Swipe Up From the Edge of the Screen

See the last photo or video you captured and access the Media Gallery.



Press and Hold the Capture Screen

Turn on and adjust Exposure Control.

Getting to Know Your GoPro

CAPTURE MODES

Your GoPro has three main capture modes.

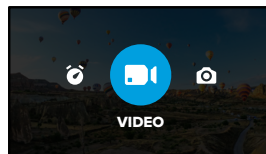

Change modes by swiping left or right to the one you want.

Video

To learn more, see [Recording Video](#) (page 33).

Photo

Includes Photo and PowerPano modes.

To learn more, see [Taking Photos](#) (page 38).

Time Lapse

Includes TimeWarp and Time Lapse modes.

To learn more, see [Capturing Time Lapse](#) (page 43).

Getting to Know Your GoPro

GETTING THE SHOT

1. Simply press the Shutter button  to start recording.



2. Press the Shutter button  again to stop recording (Video, Time Lapse, and Live Streaming only).

Getting to Know Your GoPro

CAPTURE SCREEN

This screen gives you access to your camera's capture settings.

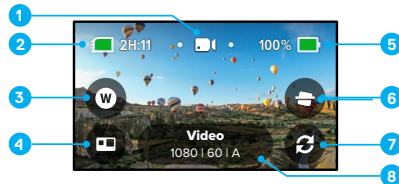

1. Current Mode (Video, Photo, or Time Lapse)
2. Recording Time/Photos Remaining
3. Digital Lens Shortcut
4. HERO/360 Mode Select
5. Battery Status
6. Horizon Lock Shortcut
7. Lens Switch
8. Capture Settings

Heads Up: The capture settings are not available when you rotate your GoPro to take portrait shots. Be sure to choose the settings you want before rotating your camera.

HERO Mode + 360 Mode

MAX lets you capture traditional HERO-style videos and photos or immersive 360 footage. Just tap HERO/360 mode select in the lower left corner of the screen to pick your shot.

HERO MODE

HERO mode  lets you shoot traditional videos and photos with either the front (non-touch screen side) or back lens (touch screen side).

1. Tap  to choose the lens you'll be using.

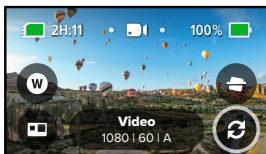



2. Press the Shutter button  to start recording.

PRO TIP: Choose HERO mode and the back lens to frame and capture awesome selfies.

HERO Mode + 360 Mode

360 MODE

Use 360 mode  to capture amazing spherical footage. View and share it as 360 content or use the GoPro app to reframe it as traditional videos and photos.

1. 360 mode captures everything around you, but you can tap  to choose which lens view will be shown on the touch screen.

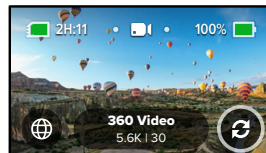

2. Press the Shutter button  to start recording.

HERO Mode + 360 Mode

360 Mode Audio Settings

In 360 mode, MAX uses its six microphones to record amazing audio that's just as immersive as the footage itself. It features two audio settings for recording 360 surround sound or stereo sound. You can also set it up to filter out excessive wind noise.

To learn more, see:

- [360 Audio](#) (page 110)
- [Wind-Noise Reduction](#) (page 111)

Tips for Capturing 360 Content

- For the best results, mount MAX on the Max Grip + Tripod (sold separately). It was specially designed for shooting 360 footage without getting the grip in your shot.
- Mounting with the Max Grip + Tripod is recommended, but if you're going to take a handheld shot, hold MAX near its base to minimize how much of your hand gets into your footage.



CAUTION: Do not use the folding fingers to hold your camera. They can heat up during recording. Leave the fingers folded for handheld shots.

HERO Mode + 360 Mode

- Aim one of the lenses directly at your subject. Even though MAX captures everything around you, you'll get better footage if you lock in on your subject.
- Use voice commands. This will let you start capture remotely so you don't have to move your hand out of the way after pressing the Shutter button.
- Watch your 360 footage on the GoPro app to see your stabilized Video and TimeWarp shots. This will give you the smoothest 360 footage possible.
- Use Reframe in the GoPro app to turn your 360 content into amazing traditional videos and photos. You'll be able to recapture the scene from any angle as many times as you want.

Changing Modes + Settings

CHANGING MODES

1. Swipe left or right to the mode you want.

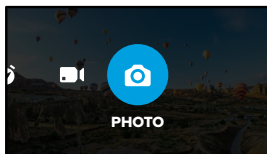

2. Tap the capture settings to see all of the available capture options.



3. Choose an option from the list.

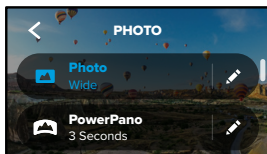

Changing Modes + Settings

CHANGING CAPTURE SETTINGS

Each mode has its own settings that can be adjusted with just a few taps.

1. Tap  next to the mode you want to change.

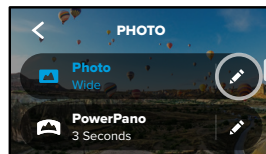

2. Tap the setting that you want to change.

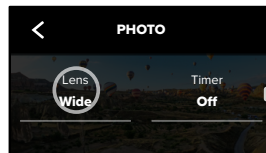

The on-screen instructions will give you a rundown of your options.



For details on settings, see [Tech Specs](#) (starting page 92).

Changing Modes + Settings

3. Scroll down for the more advanced settings.

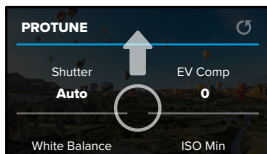

For details on all advanced settings, see [Protune](#) (starting page 101).

4. Tap  to save your changes and return to the mode selection screen.

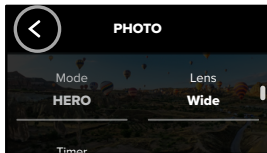

PRO TIP: From the capture screen, you can press and hold the capture settings to skip straight to the settings menu.

RESTORING THE DEFAULT SETTINGS

You can go back to your camera's original capture settings any time.

1. Swipe down to access the Dashboard.
2. Tap Preferences > Reset > Reset Defaults.

On-Screen Shortcuts

On-screen shortcuts give you quick one-tap access to your camera's capture settings. Each mode has its own default shortcuts, but you can change them to the settings that you use most. You can even set up different shortcuts for each capture mode.

1. Tap the  next to the preset you want to adjust.

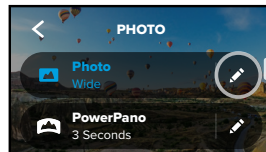

2. Scroll down to the On-Screen Shortcuts.

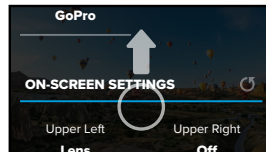

On-Screen Shortcuts

3. Tap where you'd like to put your new shortcut.

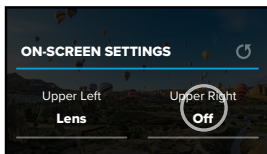

4. Scroll through all of the available shortcuts on the right and choose the one you want.

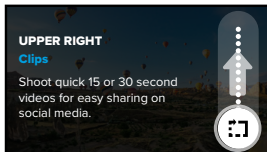

For details on shortcuts, see [Tech Specs](#) (starting page 92) and [Protune](#) (starting page 101).

On-Screen Shortcuts

5. Tap < to save your changes and return to the presets screen.

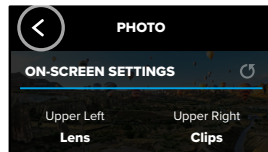

Now you can simply tap the shortcut to change settings.

PRO TIP: From the capture screen, you can press and hold the shortcut to skip to the shortcut selection screen.

Using QuikCapture

QuikCapture is the fastest and easiest way to power on your GoPro and get the shot. All it takes is the push of the Shutter button.

RECORDING WITH QUIKCAPTURE

1. With your camera off, press the Shutter button .



2. Press the Shutter button  again to stop recording and turn off your camera.

For more Video options, see [Recording Video](#) (page 33).

Using QuikCapture

Setting the Default Capture Mode

You can choose your default QuikCapture mode in Preferences.

1. Swipe down to access the Dashboard.
2. Tap Preferences > General > QuikCapture Default.

Setting	Description
Last Used (Default)	Records using the video mode and settings you used last.
HERO Mode Video	Records traditional HERO mode video.
360 Video	Records 360 video.

Using QuikCapture

TAKING TIME LAPSE WITH QUIKCAPTURE

1. With your camera off, press and hold the Shutter button  until your camera turns on (about 3 seconds). It will start recording in the last Time Lapse mode that you used.



2. Press the Shutter button  again to stop Time Lapse and turn off your camera.

For more Time Lapse options, see [Capturing Time Lapse](#) (page 43).



TURNING OFF QUIKCAPTURE

QuikCapture is on by default, but you can turn it off.

1. Swipe down to access the Dashboard.
2. Tap .

PRO TIP: Since it only turns the camera on when it's recording, QuikCapture is a great way to maximize battery life.

Adding HiLight Tags

Mark favorite moments in your videos and photos by pressing the Mode button  during recording or playback. This adds a HiLight Tag  that makes those moments easier to find when you're watching your footage, creating a video, or looking for a certain shot.

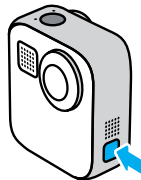

You can also add HiLight Tags by saying, "GoPro, HiLight" when Voice Control is on and by tapping  when watching your footage with the GoPro app.

PRO TIP: The GoPro app looks for HiLight Tags when it automatically creates videos. This helps ensure that favorite moments are included in your stories.

Setting the Screen Orientation

You can easily switch between landscape and portrait shots by rotating your camera. MAX can even capture photos and videos right-side up when it's mounted upside down. The touch screen menu will automatically adjust, and your media will play back right-side up.

The orientation is locked in when you press the Shutter button . If your camera tilts during recording, like on a roller coaster, your footage will tilt with it. You'll capture every twist and turn.

LOCKING THE ORIENTATION

MAX lets you lock the screen in landscape or portrait orientation. This is especially useful when you're using body and handheld mounts. That's when accidentally shooting in the wrong orientation is mostly likely to happen.

Swipe down to access the Dashboard.

1. Turn your camera to the orientation you want.
2. Tap  on the Dashboard.

The screen is now locked and will match the orientation of your camera.

Heads Up: Locking the screen in this way will only work when the Orientation is set to All (default) in Preferences.

SETTING LANDSCAPE LOCK

You can also set your GoPro to record only in landscape orientation.

Swipe down to access the Dashboard.

1. Tap Preferences > Touch Screen > Orientation.
2. Switch from All (default) to Landscape.

Your GoPro will record right-side up whether your camera is right-side up or upside down. You can also lock the orientation on the Dashboard.

Recording Video

Your GoPro can capture traditional videos with either lens in HERO mode or capture everything from every angle in 360 mode.

VIDEO

HERO mode shoots traditional videos with a resolution of 1080p or 1440p. The default settings are 1080p video at 60 frames per second (fps) with a Wide digital lens and Max HyperSmooth on. 360 mode can capture 6K source/5.6K stitched video at 30 and 24 fps or 3K source/stitched video at 60 fps for slo-mo playback.

ON-SCREEN SHORTCUTS

HERO mode features two default shortcuts, but you can swap them out for others.

Heads Up: 360 mode doesn't have default shortcuts, but you can add up to two.

To learn more, see [On-Screen Shortcuts](#) (page 25).

Recording Video

Horizon Lock (HERO Mode)

This shortcut automatically straightens out your shot by keeping the horizon level even if you rotate your camera during recording.

1. Tap .

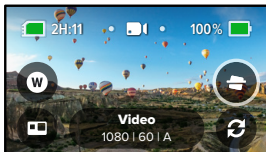

2. Press the Shutter button  to start recording.

To learn more, see *Horizon Lock* (page 96).

Recording Video

Digital Lens (HERO Mode)

Changing digital lenses on your GoPro is just like switching out the lenses on a DSLR. They affect the field of view, the cropping, and the fisheye effect in your shot.

1. Tap .

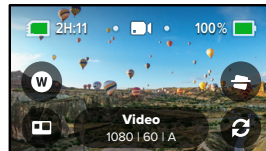

2. Scroll through the options to see a live preview of each option, and then tap the one that you want.



Video Settings

Here's a breakdown of the video settings. Tap the  and then the setting to make changes.

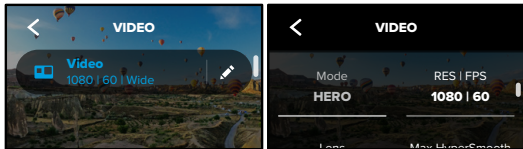

MODE

Shows you whether your camera is currently in HERO mode or 360 mode.

RES | FPS

HERO mode features two resolutions (RES). 1080p is a widescreen 16:9 resolution that's great for cinematic shots. 1440p is a tall 4:3 resolution that's for selfies and point-of-view shots.

360 mode captures 6K source/5.6K stitched spherical content at 30 frames per second (fps). It can also capture 3K source/stitched spherical content at at 60 fps, which lets you slow the footage down to 2x slo-mo during playback.

The available frame rates for both HERO mode and 360 modes are listed at the bottom of the screen.

To learn more, see:

- [Resolution](#) (page 92)
- [Frames per Second \(Video\)](#) (page 94)

Video Settings

LENS (HERO MODE)

Choose the best digital lens for your shot—Max SuperView, Wide, Linear, or Narrow.

To learn more, see [Digital Lenses \(Video\)](#) (page 95).

MAX HYPERSMOOTH (HERO MODE)

Perfect for biking, skiing, handheld shots, and more, Max HyperSmooth delivers unbreakable video stabilization for the smoothest shots possible. Max HyperSmooth is on by default.

To learn more, see [Max HyperSmooth Video Stabilization](#) (page 96).

PRO TIP: Watch your 360 footage on the GoPro app to see your Video and TimeWarp shots with full stabilization.

CLIPS

Shoot short 15- or 30-second video clips that are quick and easy to save on your phone and share on social media. Clips are off by default.

HORIZON LOCK (HERO MODE)

Gives your HERO mode footage an ultra smooth cinematic look with a level horizon even if your camera gets flipped upside down while recording.

To learn more, see [Horizon Lock](#) (page 96).

PROTUNE

Use Protune to take manual control of advanced settings, including Bit Rate, Color, ISO Limit, Exposure, microphone settings, and more.

To learn more, see [Protune](#) (page 101).

Taking Photos

Your GoPro can take traditional, 360, and panoramic photos. Simply choose the type of photo you want, and press the Shutter button . All HERO mode shots are captured at 5.5MP. 360 photos are captured at 18MP source/16.6MP stitched.

PHOTO

Use this mode to take a single photo in either HERO or 360 mode. You can also press and hold the Shutter button  in HERO mode to take a continuous series photos at a rate of 3 or 30 per second (depending on lighting conditions).

POWERPANO

PowerPano takes incredible 270° distortion-free panoramic photos without having to scan the horizon. Hold MAX horizontally for traditional panoramic photos, or rotate it to portrait orientation for amazing extra-tall shots. All PowerPano photos are captured at 6.2MP. Horizon Lock is on by default.

Heads Up: PowerPano uses both lenses to take the shot, no matter whether your subject is front of or behind your camera. Make sure both lenses are uncovered.

PRO TIP: Keep your camera level with the horizon to minimize distortion when taking a PowerPano shot.

Taking Photos

ON-SCREEN SHORTCUTS

When taking photos, HERO and 360 mode each feature one default shortcut. You can swap it out with another shortcut or add a second.

To learn more, see [On-Screen Shortcuts](#) (page 25).

Digital Lens (HERO Mode)

Digital lenses affect the field of view, the cropping, and the fisheye effect in your photo. Switch them up to see what works best for your shot.

1. Tap .

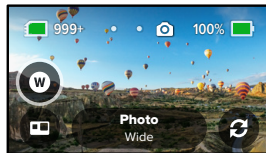

2. Scroll through the options to see a live preview of each option, and then tap the one that you want.



Taking Photos

Photo Timer (360 Mode + PowerPano)

360 photos and PowerPano shots capture everything around your camera. This can include your finger pressing the Shutter button. The Timer is set to 3 seconds by default so that you'll have enough time to reposition your hand out of the shot. You can also turn the timer off or set it to 10 seconds.

1. Tap .

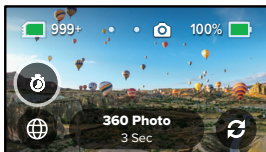

2. Choose 3 seconds, 10 seconds, or Off.



Taking Photos

3. Press the Shutter button . Your camera will start the countdown. It will also beep, and the front status light will blink. Both will speed up as the time winds down before snapping the photo.



To learn more, see [Tips for Capturing 360 Content](#) (page 20).

PRO TIP: Try using voice commands when capturing 360 shots. This will let you start capture remotely so you don't have to move your fingers out of the way after pressing the Shutter button.

To learn more, see [Controlling Your GoPro With Your Voice](#) (page 51).

Photo Settings

Here's an overview of the available photo settings. Tap the  to access the settings menu, and then tap the setting itself to make changes.

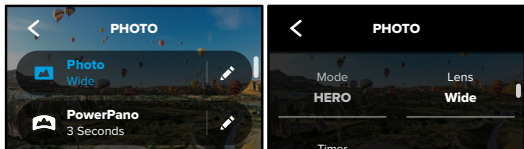

LENS (HERO MODE)

Choose best digital lens for your shot—Max SuperView or Wide. Scroll to see a live preview of each, and then tap the one you want.

To learn more, see [Digital Lenses \(Photo\)](#) (page 97).

HORIZON LOCK (HERO MODE + POWERPANO)

Helps you capture amazing panoramic shots with a level horizon even when your camera is tilted. Horizon Lock is on by default.

To learn more, see [Horizon Lock \(PowerPano\)](#) (page 97).

TIMER

Set up a 3- or 10-second timer for your photo.

PROTUNE (PHOTO)

Protune gives you manual control of advanced settings including Color, ISO Limit, Exposure, and more.

To learn more, see [Protune](#) (starting page 101).

Capturing Time Lapse

Time Lapse turns long events into short shareable videos by taking a frame of video at set intervals. All you have to do is press the Shutter button  to start recording, and then press it again to stop.

TIMEWARP

MAX lets you speed up time by using TimeWarp video stabilization to capture ultra smooth time lapse video while you're on the move. This makes it perfect for mountain bike runs, hikes, and more.

In HERO mode, you can also tap  to slow down the effect to real time—savoring interesting moments—and then tap to speed it back up.

TIME LAPSE

Use Time Lapse when your camera is mounted and still. It's great for sunsets, street scenes, art projects, and other shots that unfold over a long period of time.

PRO TIP: MAX can also capture Time Lapse photos. Simply go to Format in settings and chose Photo.

Capturing Time Lapse

ON-SCREEN SHORTCUTS

Time Lapse mode includes one default shortcut for HERO mode (Digital Lens), but you can switch it out for a different shortcut or add another.

To learn more, see [On-Screen Shortcuts](#) (page 25).

Digital Lens (HERO mode)

Swap out digital lenses to change the field of view, the cropping, and the fisheye effect in your shot.

1. Tap **W**.



2. Scroll through the options to see a live preview of each option, and then tap the one that you want.



Time Lapse Settings

Here's where you can make adjustments to your Time Lapse settings. Tap the  and then tap the setting to make changes.

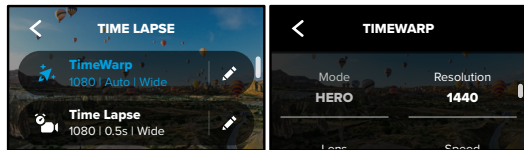

RESOLUTION

HERO mode features two resolutions (RES) in both TimeWarp and Time Lapse mode. 1080p is a widescreen 16:9 resolution that's great for cinematic shots. 1440p is a tall 4:3 resolution that's great for selfies and POV shots. In TimeWarp mode, all 360 footage can be shot in 6K source/5.6K stitched or 3K stitched/captured.

To learn more, see [Resolution](#) (page 92).

LENS

Choose best digital lens for your shot. Scroll through the options to see a live preview of each, then tap the one you want.

Heads Up: Available lenses will vary based on the mode you select.

To learn more, see [Digital Lenses \(Photo\)](#) (page 97).

Time Lapse Settings

SPEED (TIMEWARP)

Set your video speed. Choose a lower speed (2x or 5x) for short activities or higher speeds (10x, 15x, or 30x) for longer activities. In HERO mode, Auto lets your GoPro automatically adjust the speed based on motion, scene detection, and lighting.

To learn more, see [TimeWarp Video Speed](#) (page 98).

FORMAT (HERO MODE)

Switch from capturing Time Lapse Video to Time Lapse Photo. The photo format takes a continuous series of photos at set intervals. This lets you focus on your activity instead of on your camera. You can then look through all of your photos and find the best shots later.

INTERVAL (TIME LAPSE)

Choose how often your camera captures a frame of time lapse video or takes a time lapse photo. Use shorter intervals for quick activities and longer intervals for extended activities.

To learn more, see [Time Lapse Interval](#) (page 99).

HORIZON LOCK (HERO MODE TIMEWARP)

Smooths out your HERO mode TimeWarp footage by keeping the horizon smooth and level horizon even if your camera is turned completely upside down while recording.

To learn more, see [Horizon Lock](#) (page 96).



PROTUNE (TIMEWARP, TIME LAPSE VIDEO)

Protune gives you manual control of advanced settings including Color, ISO Limit, Exposure, and more.

To learn more, see [Protune](#) (starting page 101).

Live Streaming

SETTING UP A LIVE STREAM

1. Connect to the GoPro app. For details, see [Connecting to the GoPro App](#) (page 59).
2. In the app, tap  to control your camera.
3. Tap  and follow the instructions to set up your stream.

For complete step-by-step instructions, visit gopro.com/live-stream-setup.

Exposure Control

MAX automatically scans the entire scene to choose the exposure level for your shot. Exposure Control lets you decide if only a section of the shot should be used to set the exposure.

Check out the shot preview on your touch screen. Try Exposure Control if there are sections that are too dark or too light.

SETTING EXPOSURE CONTROL USING AUTO EXPOSURE

With this option, the camera automatically bases exposure on the area that you select.

Imagine your camera is mounted on your dashboard. You probably want to set the exposure based on the scene outside the car instead of the dashboard. This will help prevent your shots from being overexposed (too bright).

1. Press the touch screen until a set of brackets with a dot in the middle appears in the center of the screen. This is the Spot Meter. It will base the exposure on the center of the shot.
2. Drag the brackets away from the center if you want to use another area of the shot to set the exposure. (You can also tap that area instead of dragging the brackets.)
3. Check the screen to see if the exposure looks good. Tap  in the lower right corner.



Exposure Control

SETTING EXPOSURE CONTROL USING LOCKED EXPOSURE

With this option, your camera locks the exposure until you cancel it.

If you're snowboarding on a sunny day, you might try locking the exposure on your subject's jacket. This will help prevent your shots from being underexposed (too dark) compared to the bright snow.

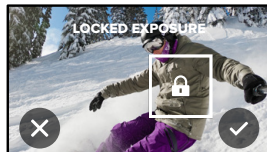

1. Press the touch screen until a set of brackets with a dot in the middle appears in the center of the screen. This is the Spot Meter. It will base the exposure on the center of the shot.
2. Drag the brackets away from the center if you want to use another area of the shot to set the exposure. (You can also tap that area instead of dragging the brackets.)
3. Tap inside the brackets to lock the exposure.
4. Check the screen to see if the exposure looks good. Tap  in the lower right corner to lock it in.



Exposure Control

EXPOSURE CONTROL IN 360 MODE

In 360 mode, you can set the exposure based on any area of the shot using either lens.

1. Press the touch screen until a square appears in the middle.
2. Tap  to switch between the view from each lens.
3. Drag the brackets away from the center if you want to use another area of the shot to set the exposure. (You can also tap that area instead of dragging the brackets.)
4. Check the screen to see if the exposure looks good. Tap  in the lower right corner.

TURNING EXPOSURE CONTROL OFF

Exposure Control is automatically turned off when you switch capture modes or restart your camera. It can also be turned off manually.

5. Press the touch screen until a square appears in the middle.
6. Tap  in the lower left corner.

Heads Up: After canceling Exposure Control, your camera will go back to automatically using the entire scene to set the exposure level.

Controlling Your GoPro With Your Voice

Voice Control gives you easy, hands-free control of your GoPro. It's great when you're busy with handlebars, ski poles, and more. Just tell your GoPro what you want it to do.

TURNING VOICE CONTROL ON + OFF

1. Swipe down to access the Dashboard.
2. Tap  to turn Voice Control on or off.

CAPTURING WITH VOICE CONTROL

With Voice Control on, you can simply tell your GoPro to start capturing.

Command	Description
GoPro, capture	Starts capturing with the mode your camera is set to.
GoPro, stop capture	Stops capture in Video and Time Lapse modes.

PRO TIP: Saying "GoPro, capture" and "GoPro, stop capture" is the hands-free way of pressing the Shutter button. They will start and stop capture using the mode and settings you currently have on your camera.

Controlling Your GoPro With Your Voice

LIST OF VOICE COMMANDS

There are two types of voice commands: Action commands and Mode commands.

Using Action Commands

These commands let you switch modes on the fly. If you just recorded a video, you can say, "GoPro take a photo" to snap a photo without manually switching modes.

Action Command	Description
GoPro, start recording	Starts recording video.
GoPro, HiLight	Adds a HiLight Tag to your video during recording.
GoPro, stop recording	Stops recording video.
GoPro, take a photo	Takes a single photo.
GoPro, start time lapse	Starts capturing with the last Time Lapse mode you used.
GoPro, stop time lapse	Stops capturing time lapse.
GoPro, turn off	Turns your camera off.

Controlling Your GoPro With Your Voice

Using Mode Commands

Use these commands to switch capture modes on the go. Then say, "GoPro, capture" or press the Shutter button to get the shot.

Mode Command	Description
GoPro, Video mode	Switches your camera to Video mode (does not start recording).
GoPro, Photo mode	Switches your camera to Photo mode (does not take a photo).
GoPro, Time Lapse mode	Switches your camera to Time Lapse photo mode (does not start taking time lapse photos).

PRO TIP: If you're recording video or time lapse, you must stop recording by pressing the Shutter button or by saying, "GoPro, stop capture" before trying a new command.

Controlling Your GoPro With Your Voice

SEE A COMPLETE LIST OF COMMANDS ON YOUR CAMERA

1. Swipe down to access the Dashboard.
2. Tap Preferences > Voice Control > Commands.

CHANGING YOUR VOICE CONTROL LANGUAGE

1. Swipe down to access the Dashboard.
2. Tap Preferences > Voice Control > Language.









Heads Up: Voice Control may be affected by wind, noise, and your distance from the camera. Keep your camera clean, and wipe away any debris for the best performance.

Playing Back Your Media

Swipe up to see the last video, photo, or time lapse you took. Swipe left and right to flip through the other files on your SD card.



The Media Gallery includes the following playback options:

-  Pause playback
-  Resume playback
-  See all of the media on your SD card
-  Delete the file from your SD card
-  Playback view
-  Play back at slo-mo or normal speed
-  Use a slider to scan through your videos or group of continuous photos
-  Add/remove HiLight Tag

Playing Back Your Media

 Adjust the playback volume

  Go to the previous or next photo in a group of continuous photos

Heads Up: The playback options will vary based on the type of media you're viewing.

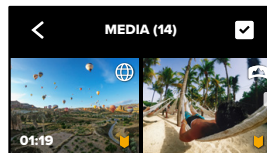

PRO TIP: Some playback options are not available when you're holding your camera in portrait orientation. Make adjustments to those settings in landscape orientation before rotating your camera.

Playing Back Your Media



USING GALLERY VIEW



Gallery view gives you quick access to all of the videos and photos stored on your SD card.

1. From the playback screen, tap .
2. Swipe up to scroll through your media.
3. Tap a video or photo to see it in full-screen view.
4. Tap  to select files.
5. Tap  to go back to the playback screen.

Heads Up: Gallery view is not available when you're holding your camera in portrait orientation. Also, the more content you have on your SD card, the longer it will take to load.

Playing Back Your Media

Deleting Multiple Files

1. Tap .
2. Tap all of the files that you want to delete. Tap a file again if you want to de-select it.
3. Tap  to delete the selected files.

VIEWING VIDEOS + PHOTOS ON A MOBILE DEVICE

1. Connect your camera to the GoPro app. For details, see [Connecting to the GoPro App](#) (page 59).
2. Use the controls on the app to play back, edit, and share your videos and photos.

PRO TIP: Use the GoPro app to grab still photos from videos, create short shareable videos from full-length footage, save media to your phone, and more.

VIEWING VIDEOS + PHOTOS ON A COMPUTER

To see your media on a computer, you must first save the files to the computer. To learn more, see [Transferring Your Media](#) (page 61).

Connecting to Other Devices

CONNECTING TO THE GOPRO APP

Use the GoPro app to control your MAX, share videos and photos on the go, and automatically transform your footage into awesome video stories synced with effects and music.

Connecting for the First Time

1. Download the GoPro app from the Apple® App Store® or Google Play™.
2. Follow the app's on-screen instructions to connect your camera.
Heads Up for iOS®: When prompted, be sure to allow notifications from the GoPro app so you know when your video is ready.
To learn more, see [Creating Video Stories](#) (page 61).

FINDING THE BEST SHOTS

After you've connected once, you can start connecting through your camera's Connections menu.

1. If your camera's wireless is not already on, swipe down to access the Dashboard.
2. Tap Preferences > Connections > Connect Device.
3. Follow the on-screen instructions in the GoPro app to connect.

Connecting to Other Devices

SETTING THE CONNECTION SPEED

Your GoPro is set to use the 5GHz Wi-Fi band (the fastest available) when connecting to other mobile devices.

Change the Wi-Fi band to 2.4GHz if your device or region does not support 5GHz.

1. Swipe down to access the Dashboard.
2. Tap Preferences > Connections > Wi-Fi Band.

Transferring Your Media

CREATING VIDEO STORIES

You can set up your GoPro to automatically send videos and photos to your phone. The GoPro app will use them to create fully edited video stories complete with music and effects.

1. Connect your camera to the GoPro app. For details, see [Connecting to the GoPro App](#) (page 59).
2. Swipe down on the app's home screen. Shots from your most recent session will be copied to your phone and transformed into a fully edited video.
3. Tap your video to view it.
4. Make any edits you'd like.
5. Save the story or share it with your friends, family, and followers.

Finding the Best Shots

Be sure to mark your best shots with HiLight Tags. The GoPro app looks for tags when it creates videos. This helps ensure that favorite moments are included in your stories.

To learn more, see [Adding HiLight Tags](#) (page 31).

Transferring Your Media

TRANSFERRING YOUR MEDIA TO A COMPUTER

1. Be sure that your computer is running the latest version of its operating system.
2. Download and install the GoPro Player for Mac® or Windows® from gopro.com/apps.
3. Remove the SD card from your camera.
4. Insert the card into an SD card reader or adapter.
5. Plug the card reader into your computer's USB port or insert the adapter into the SD card slot.
6. Open the files on the SD card. GoPro Player will automatically open and play .360 files.⁴

Heads Up: Your computer's default importer will open and play .mp4 and .jpg files.

Transferring Your Media

AUTO UPLOADING TO THE CLOUD

With a GoPro subscription, you can automatically upload your media to the cloud where you can view, edit, and share it from any device.

1. Subscribe to GoPro at gopro.com/subscribe or through the GoPro app.
2. Connect your camera to the the GoPro app. For details, see *Connecting to the GoPro App* (page 59).
3. Tap  on the camera chooser screen.
4. Connect your camera to a power outlet. The upload will start automatically.

After first-time setup, your camera won't need to connect to the app to start Auto Upload.

Heads Up: Your original files remain on your camera even after they've been backed up to the cloud.

PRO TIP: Use the GoPro app to connect to a different wireless network when you're away from home. The network can't be hidden or require an end-user license agreement (for example, a network in a hotel).

Transferring Your Media

SWITCHING TO MANUAL CLOUD UPLOAD

You can also manually upload your media to the cloud at any time. (Your GoPro must be connected to a power outlet, and Auto Upload must be off.)

1. Connect your camera to a power outlet.
2. Swipe down to access the Dashboard.
3. Tap Preferences > GoPro Subscription > Manual Upload.

ACCESSING YOUR CLOUD MEDIA

1. Open the GoPro app on your device.
2. Tap  and select Cloud to view, edit, and share your content.

PRO TIP: Use your cloud media to create video stories with the GoPro app. Simply choose Cloud Media when you start a new story.

Transferring Your Media

TURNING OFF AUTO UPLOAD

You can keep your camera from trying to upload every time it's connected to a power outlet.

1. Swipe down to access the Dashboard.
2. Tap Preferences > GoPro Subscription > Auto Upload.
3. Tap Off.

CHANGING YOUR GOPRO SUBSCRIPTION PREFERENCES

Manage your Auto Upload settings, set up your wireless network, and more.

1. Swipe down to access the Dashboard.
2. Tap Preferences > GoPro Subscription.

Heads Up: GoPro Subscription will be available in your Preferences after you've signed up.

Customizing Your GoPro





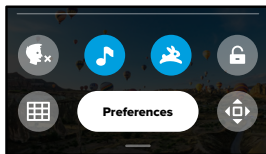

USING THE DASHBOARD

With your camera in landscape orientation, swipe down to access the Dashboard and Preferences.



DASHBOARD FEATURES

The Dashboard lets you quickly tap the following settings on and off:





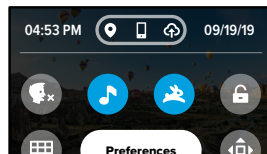



-  Voice Control
-  Camera Beeps
-  QuikCapture
-  Screen Lock
-  Grid
-  Orientation Lock

Customizing Your GoPro



CONNECTION STATUS

Check the top of the Dashboard to see your connection status.

-  GPS is on (white).
-  GPS is off (gray).
-  GPS is unavailable (gray).
-  Camera is connected to the GoPro app (white).
-  Camera is not paired to the GoPro app (gray).
-  Camera is not connected to the GoPro app (gray).
-  Auto Upload is on and ready (white).
-  Auto Upload is off (gray).
-  Auto Upload is on but not ready (gray).

Customizing Your GoPro

CHANGING PREFERENCES

Preferences let you set up your GoPro any way you want.



CONNECTIONS

Set all of your GoPro's wireless connections.

Wireless Connections

Turn your camera's wireless connections on and off.

Connect Device

Connect to the GoPro app or The Remote. To learn more, see *Connecting to the GoPro App* (page 59).

Camera Info

See your camera's name and password.

Wi-Fi Band

Choose 5GHz or 2.4GHz as your connection speed. Set 5GHz only if your phone and region support it. To learn more, see *Setting the Connection Speed* (page 60).

Reset Connections

Use to reset all of your wireless connections to their default settings.

Customizing Your GoPro



GENERAL

Here's everything you'll find under General settings:

Beep Volume

Choose High (default), Med, Low, or Off. The volume you set here can be toggled on or off using the Dashboard.

QuikCapture

QuikCapture is on by default. You can turn it off here. It can also be toggled on or off using the Dashboard.

QuikCapture Default

Choose the video mode you'd like to use when you start QuikCapture.

Default Mode

Set the mode your GoPro captures in when you turn it on using the Mode button . This setting does not affect QuikCapture.

Auto Power Off

Choose 5 Min, 15 Min (default), 30 Min, or Never.

LEDs

Set which status lights blink. Choose All On (default), All Off, or Front Off.

Anti-Flicker

Choose the regional frame rate for recording and playback on a TV. Set 60Hz (NTSC) for North America. Try 50Hz (PAL) if you're outside North America. The right format for your region will help prevent flicker on a TV/HDTV when you play back video that was recorded indoors.

Customizing Your GoPro

Video Compression

Set the file format for your videos. Choose HEVC (to reduce file sizes) or H.264 + HEVC (to use H.264 to maximize compatibility with older devices while using HEVC for advanced settings).

Time and Date

Use to manually adjust the time and date. Both are automatically updated when you connect your camera to the GoPro app.

Date Format

This is set automatically based on the language that you chose at setup. You can also change it manually here.



VOICE CONTROL

Choose your Voice Control settings and see all of the available commands.

Voice Control

Turn Voice Control on and off. It can also be toggled on or off using the Dashboard.

Language

Choose your Voice Control language.

Commands

See a complete list of voice commands.

To learn more, see [Controlling Your GoPro With Your Voice](#) (page 51).

Customizing Your GoPro



TOUCH SCREEN

Adjust Orientation, set the Screen Saver, and adjust brightness.

Orientation

Keeps your screen right-side up when you rotate your camera.

To learn more, see [Setting the Screen Orientation](#) (page 32).

Screen Saver

Set your camera's screen saver to 1, 2, or 3 minutes. Choose Never to leave your screen on.

Heads Up: The camera buttons and Voice Control still work even when the screen is off.

Brightness

Use the slider to adjust your screen's brightness.

Customizing Your GoPro



REGIONAL

Turn on GPS, choose your language, and see all of your camera's regulatory information.

GPS

Turn on GPS to track your speed, distance, and more. Add performance stickers in the GoPro app to show how fast, far, and high you were going in your videos. For more information and mobile device compatibility, check out gopro.com/telemetry.

Language

Choose the language that appears on the camera.

Regulatory

See your GoPro's certifications.

Customizing Your GoPro



ABOUT

Update your GoPro, plus find your camera's name, serial number, battery condition, and software version.

GoPro Updates

Update your camera with the latest software to ensure you have the latest features and performance upgrades.

Camera Info

See your camera's name, serial number, and the current software version.

Battery Info

Check your battery's health here. Be sure to use the MAX Rechargeable Battery. Using an older GoPro battery or non-GoPro battery could greatly limit your camera's performance.

Customizing Your GoPro



RESET

Format your SD card or reset your camera's settings.

Format SD Card

Reformat your SD card. This will erase all of your media, so be sure to save it first.

Reset Defaults

Reset all capture settings to their default settings.

Reset Camera Tips

See all of the camera tips from the beginning.

Factory Reset

Restore all of your camera's settings and clear all connections.

Important Messages



HIGH TEMPERATURE

The Temperature icon appears on the touch screen if your camera becomes too hot and needs to cool down. Your camera was designed to recognize when it's at risk of overheating and will shut down when needed. Simply let it sit and cool before using it again.

Heads Up: The operating ambient temperature range of your camera is 14° F ~ 95° F (10° C ~ 35° C). High temperatures will cause your camera to use more power and will drain the battery faster.

PRO TIP: Shooting video at a high resolution and frame rate will also cause your camera to heat up faster, especially in hot environments. Try switching to a lower resolution and frame rate to lower the risk of overheating your GoPro.

Important Messages



FILE REPAIR

MAX will automatically try to fix damaged files. Files can be damaged if your camera loses power while recording or if there's a problem saving the file. The File Repair icon will appear on the touch screen when a repair is in progress. Your camera will let you know when it's finished and if the file was fixed.

MEMORY CARD FULL

Your camera will let you know when your SD card is full. You'll need to move or delete some files if you want to keep recording.

BATTERY LOW, POWERING OFF

A low battery message will appear on the touch screen when the battery charge drops below 10%. If the charge runs out while recording video, your camera will stop recording, save the video, and turn itself off.

Resetting Your Camera

RESTARTING YOUR GOPRO

If your camera is not responding, press and hold the Mode button  for 10 seconds. This will restart your camera. There will be no changes to your settings.

RESTORE ALL SETTINGS TO THE DEFAULTS

This will reset all of your camera settings to their defaults.

1. Swipe down to access the Dashboard.
2. Tap Preferences > Reset > Reset Defaults.

RESETTING CONNECTIONS

This will clear your device connections and reset your camera's password. Resetting connections means you'll have to reconnect all of your devices.

1. Swipe down to access the Dashboard.
2. Tap Preferences > Connections > Reset Connections.

RESETTING THE CAMERA TIPS

Want to see the camera tips again? Here's how to see them all from the beginning.

1. Swipe down to access the Dashboard.
2. Tap Preferences > Reset > Reset Camera Tips.

Resetting Your Camera

RESTORING FACTORY SETTINGS

This will restore all of your camera's original settings, clear all device connections, and deregister your camera from GoPro PLUS. This is useful if you're giving your camera to a friend and want to completely reset it to its original state.

1. Swipe down to access the Dashboard.
2. Tap Preferences > Reset> Factory Reset.

Heads Up: Restoring the factory settings will not delete any content from your SD card or have any effect on your camera's software.

Mounting Your GoPro



1



2



3

MOUNTING HARDWARE

1. Mounting Buckle
2. Thumb Screw
3. Curved Adhesive Mount

Mounting Your GoPro

ATTACHING YOUR CAMERA TO MOUNTS

Depending on the mount you're using, you'll either use a mounting buckle or attach your GoPro directly to the mount itself.

See [Using Adhesive Mounts](#) (page 82) for tips on using adhesive mounts.

1. Flip the folding fingers down into the mounting position.
2. Interlock the folding fingers on your camera with the mounting fingers on the buckle.
3. Secure your camera to the mounting buckle with a thumb screw.

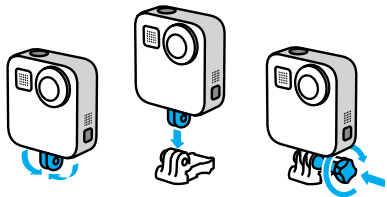

Mounting Your GoPro

4. Attach the mounting buckle to the mount.
 - a. Flip up the mounting buckle plug.
 - b. Slide the buckle into the mount until it clicks into place.
 - c. Press the plug back down so that it sits flush with the buckle.

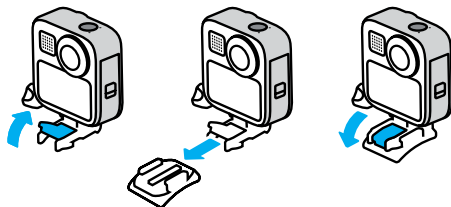

Mounting Your GoPro

USING ADHESIVE MOUNTS

Follow these guidelines when attaching adhesive mounts to helmets, vehicles, and gear:

- Attach mounts at least 24 hours before you use them.
- Only attach the mounts to smooth surfaces. They won't stick properly to porous or textured surfaces.
- Firmly press mounts into place. Be sure the adhesive is in full contact with the surface.
- Only use on clean, dry surfaces. Wax, oil, dirt, or other debris will weaken the bond, and you could lose your camera.
- Attach mounts in room temperature conditions. They won't stick properly in cold or damp environments or on cold or damp surfaces.
- Check state and local regulations and laws to ensure that attaching a camera to equipment (such as hunting gear) is permitted. Always comply with regulations that restrict the use of consumer electronics or cameras.

For more information about mounts, visit gopro.com.

Mounting Your GoPro

WARNING: The Curved Adhesive Mount and Mounting Buckle included with MAX may be used for helmet mounting. Do not use the Curved Fusion Mount (included with Fusion Mounts, sold separately) to mount MAX to a helmet.

Always use a helmet that meets applicable safety standards if you're using a GoPro helmet mount or strap.



Choose the right helmet for your sport or activity, and make sure that it's the right size and fit for you. Check to see that your helmet's in good condition, and always follow the manufacturer's instructions on safe use.

Replace any helmet that's been subjected to a major impact. No helmet can protect against injury in every accident. Be safe.

To avoid injury, do not use a tether when mounting the camera on a helmet. Do not mount the camera directly on skis or snowboards.

USING YOUR GOPRO AROUND WATER

MAX is waterproof to 16ft (5m). You won't need an additional housing to capture surf footage or any other shots on the water. MAX is not designed for underwater use.

The touch screen may not work when wet, but you can use the Mode button  to switch between Video, Photo, and Time Lapse modes when your camera is on.

PRO TIP: Use Screen Lock to prevent water from accidentally triggering and changing settings on the touch screen.

1. Swipe down to access the Dashboard.
2. Tap .

Removing the Door

There might be times when you need to remove your camera's door.



WARNING: Only remove the door in a dry, dust-free environment. The camera is not waterproof when the door is open or removed.

REMOVING THE DOOR

1. Unlock the door, slide it down, and flip it open.
2. Gently force the door open until it snaps off.

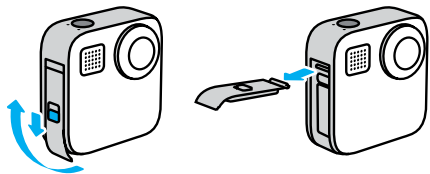

WARNING: Avoid using MAX with the door off. The battery could slide out during use.

Removing the Door

REATTACHING THE DOOR

1. Line the door up with the small silver bar.
2. Press the door tightly into the small silver bar until it snaps into place and is securely attached.

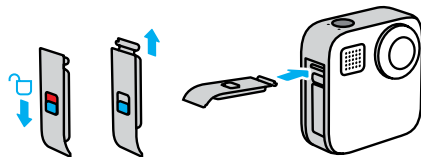

NOTICE: Slide the door all the way up until there's no gap, and then lock it. Don't use the lock to slide the door closed.

Maintenance

Here are some more tips to get the best performance from your camera:

- Always use the black lens caps to protect the lenses when you're not using your camera. The lenses are exposed to capture spherical content and are unprotected. Scratches to the lenses are not covered under the warranty.
- Use the clear Protective Lenses if you want added lens protection when you're using your camera. **NOTICE:** The clear lenses may affect image quality under certain conditions.
- To protect the lenses from damage, do not rest your camera on its front or back side. Be sure the lenses are not resting against any surface.

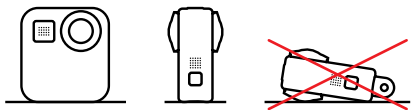

To clean the lenses, wipe them with a soft, lint-free cloth. If debris gets stuck between the lens and the trim ring, flush it out with water or air. Do not insert foreign objects around the lenses.

- Your camera is waterproof to 16ft (5m)—no housing needed. Be sure the door is closed before using the camera around water, dirt, or sand.
- Before closing the door, be sure the seal is free of debris. Use a cloth to clean the seal if needed.
- Before opening the doors, be sure that your camera is clean and dry. Rinse your camera with fresh water and dry it with a cloth if needed.

Maintenance

- If sand or debris hardens around the doors, soak your camera in warm tap water for 15 minutes and then rinse thoroughly to remove the debris. Make sure your camera is dry before opening the doors.
- For best audio performance, shake your camera or blow on the mics to remove water and debris from the microphone holes. Do not use compressed air to blow into the mic holes. This could damage the internal waterproof membranes.
- After every use in salt water, rinse your camera with fresh water, and dry with a soft cloth.



WARNING: The dual lenses of MAX are unprotected and are susceptible to scratches, if not cared for properly. Always store MAX with the provided lens protection and avoid resting the lens on any surface. Scratches to the lens are not covered by the warranty.

Battery Information

MAXIMIZING BATTERY LIFE

A low battery message will appear on the touch screen when the battery charge drops below 10%.

If the charge runs out while recording video, your camera will stop recording, save the video, and turn itself off.

Here are some things you can do to maximize battery life:

- Capture video at lower frame rates and resolutions.
- Use the Screensaver and lower the screen Brightness.
- Turn off GPS.
- Turn off Wireless Connections.
- Use these settings:
 - [QuikCapture](#) (page 28)
 - [Auto Power Off](#) (page 69).

RECORDING WHEN PLUGGED INTO A POWER SOURCE

You can use the USB-C cable that came with your camera to shoot videos and photos while your camera is plugged in to a USB-charging adapter, the GoPro Supercharger, another GoPro charger, or the GoPro Portable Power Pack. This is perfect for capturing long videos and time lapse events.

Even though your camera is charging, the battery will not charge during recording. It will start charging when you stop recording. You cannot record while plugged into a computer.

Heads Up: Because the door is open, your camera is not waterproof when charging.

Battery Information



WARNING: Using a non-GoPro wall charger could damage your camera battery and could lead to fire or leakage. With the exception of the GoPro Supercharger (sold separately), only use chargers marked Output 5V 1A. If you don't know your charger's voltage and current, use the included USB cable to charge your camera with a computer.

BATTERY STORAGE + HANDLING

MAX is full of sensitive components, including the battery. Avoid exposing your camera to very hot or cold temperatures. Extreme temperatures may temporarily shorten battery life or cause your camera to temporarily stop working properly. Avoid dramatic temperature or humidity changes as condensation may form on or within the camera.

Do not dry your camera with an external heat source such as a microwave oven or hair dryer. Damage to the camera or battery caused by contact with liquid inside the camera is not covered under the warranty.

Do not store your battery with metal objects like coins, keys, or necklaces. If the battery terminals come in contact with metal objects, this may cause a fire.

Do not make any unauthorized alterations to your camera. Doing so may compromise safety, regulatory compliance, and performance, and may void the warranty.

Heads Up: Batteries have reduced capacity in cold weather. This affects older batteries even more. If you regularly shoot at low temperatures, replace batteries yearly for optimal performance.

PRO TIP: Fully charge your camera before storing it away to help maximize battery life.

Battery Information



WARNING: Do not drop, disassemble, open, crush, bend, deform, puncture, shred, microwave, incinerate, or paint your camera or battery. Do not insert foreign objects into any opening on the camera, such as the USB-C port. Do not use your camera if it's been damaged—for example, if cracked, punctured, or harmed by water. Disassembling or puncturing the integrated battery can cause an explosion or fire.

BATTERY DISPOSAL

Most rechargeable lithium-ion batteries are classified as non-hazardous waste and are safe for disposal in the normal municipal waste stream. Many regions require battery recycling. Check your local laws to make sure that you can dispose of rechargeable batteries in your regular trash. To safely dispose of lithium-ion batteries, protect terminals from exposure to other metal with packing, masking, or electrical tape so they do not cause a fire while being transported.

Lithium-ion batteries, however, do contain recyclable materials and are accepted for recycling by the Rechargeable Battery Recycling Corporation's (RBRC) Battery Recycling Program. We encourage you to visit Call2Recycle at call2recycle.org or call 1-800-BATTERY in North America to find a convenient recycling location.

Never dispose of a battery in a fire because it may explode.



WARNING: Only use GoPro replacement batteries for your camera.

Troubleshooting

MY GOPRO WON'T POWER ON

Make sure your GoPro is charged. See [microSD Card + Battery Setup](#) (page 9). If charging the battery didn't work, try restarting your camera. See [Restarting Your GoPro](#) (page 77).

MY GOPRO WON'T RESPOND WHEN I PRESS A BUTTON

See [Restarting Your GoPro](#) (page 77).

PLAYBACK ON MY COMPUTER IS CHOPPY

Choppy playback is usually not a problem with the file. If your footage skips, one of these issues is probably the cause:

- The computer doesn't work with HEVC files. Try downloading the latest version of the GoPro Player Mac® or Windows® free at gopro.com/apps.
- Your computer doesn't meet the minimum requirements of the software you're using for playback.

I FORGOT MY CAMERA'S USERNAME OR PASSWORD

Swipe down to access the Dashboard, and then tap Preferences > Connections > Camera Info.

I DON'T KNOW WHICH SOFTWARE VERSION I HAVE

Swipe down to access the Dashboard, and then tap Preferences > About > Camera Info (scroll down to see your software version).

I CAN'T FIND MY CAMERA'S SERIAL NUMBER

The serial number is stamped inside the battery compartment of your camera. You can also find it by swiping down to access the Dashboard, and then tapping Preferences > About > Camera Info.

For more answers to commonly asked questions, see gopro.com/help.

Tech Specs: Video

RESOLUTION (VIDEO, TIMEWARP, TIME LAPSE)

Video resolution refers to the number of horizontal lines used in each frame of video. MAX features a choice two resolutions in both HERO mode and 360 mode.

HERO Mode Resolution	Description
1080p	The standard resolution and aspect ratio (16:9) for HDTV. Use 1080p if you want full-screen playback on your TV or phone.
1440p	The tall 4:3 aspect ratio fits more into the frame than 1080p. Great for selfies, point-of-view shots, and sharing to social media. <i>Heads Up:</i> Black bars will appear on both sides of the screen when playing back 1440p footage on an HDTV.

Tech Specs: Video

360 Mode Resolution	Description
6K Source, 5.6K Stitched	High resolution 360 video that captures everything around you in stunning detail. Lets you create amazing 1080p30 traditional videos using Reframe in the GoPro app.
3K Source/Stitched	Records video at 60 frames per second (fps) that can be slowed down to 2x normal speed during playback. Lets you create 720p60 traditional videos using Reframe in the GoPro app.

PRO TIP: Be sure that your phone, computer, or TV can support 5.6K video before recording.

Tech Specs: Video

FRAMES PER SECOND (VIDEO)

Frames per second (fps) refers to the number of frames captured in each second of video. A higher fps value (60 fps) is better at capturing fast-action shots. You can also use high fps footage for slow-motion playback.



High Resolutions/High Frame Rates

Shooting high-resolution or high-fps video when it's warm out can cause your camera to heat up and use more power.

Lack of airflow and connecting to the GoPro app can cause your camera to warm up even more, use even more power, and shorten recording time.

If heat's a problem, try recording shorter videos. Also limit use of features that take a lot of power, like the GoPro app.

Your camera will tell you if it needs to shut down and cool off. To learn more, see [Important Messages](#) (page 75).

Tech Specs: Video

DIGITAL LENSES (HERO MODE-VIDEO)

Digital lenses let you choose how much of the scene is captured by your camera. The different lenses also affect the zoom level and the fisheye effect in your shot. For Video mode, Max SuperView captures the largest field of view while Narrow captures the smallest.

Setting	Description
Max SuperView (13mm)	Widest, most immersive field of view ever on a GoPro.
Wide (16mm)	Wide field of view with less fisheye effect than Max SuperView.
Linear (19mm)	Wide field of view without the fisheye effect.
Narrow (27mm)	Narrow field of view without the fisheye effect.

Tech Specs: Video

MAX HYPERSMOOTH VIDEO STABILIZATION (HERO MODE)

Max HyperSmooth gives you unbreakable stabilization by using a 180° field of view as the ultimate video buffer. It lets your camera eliminate almost all bumps and shakes while you're recording. This makes it perfect for biking, skating, handheld shots, and more.

PRO TIP: Watch your 360 footage on the GoPro app to see your Video and TimeWarp shots with full stabilization.

HORIZON LOCK (HERO MODE)

Horizon Lock keeps your footage smooth and level even if your camera gets flipped upside down while recording.

With Horizon Lock on, your footage and the live view on the touch screen will be locked into the orientation your camera was in when you pressed the Shutter button. If your camera was in a portrait orientation, your footage will stay in a level portrait orientation no matter how much your camera rotates.

With Horizon Lock off, your footage and the live view on the touch screen will roll with the rotation of your camera.

PRO TIP: To capture all the twists of barrel rolls, banked turns, and other activities, make sure that Horizon Lock is off when you're shooting extreme POV action.

Tech Specs: Photo

DIGITAL LENSES (HERO MODE-PHOTO)

The field of view (FOV) refers to how much of the scene is captured by your camera. MAX takes photos using two fields of view.

Setting	Description
Max SuperView (13mm)	Widest, most immersive field of view ever on a GoPro.
Wide (16mm)	Wide field of view will less fisheye effect than Max SuperView.

HORIZON LOCK (POWERPANO)

Horizon Lock helps you capture amazing panoramic photos with a level horizon even when your camera isn't perfectly straight.

With Horizon Lock on, the live view on your camera's touch screen will match the angle that your camera is tilted. The horizon is automatically locked when you press the Shutter button to take the shot. You can check out the results by swiping up to see the photo in the Media Gallery.

Horizon Lock works for both horizontal and vertical PowerPano shots.

PRO TIP: Use Landscape Lock to avoid capturing vertical PowerPano shots by mistake. This can happen if you accidentally tilt your camera too close to vertical.

To learn more, see [Setting the Screen Orientation](#) (page 32).

Tech Specs: Time Lapse

TIMEWARP VIDEO SPEED

You can increase TimeWarp video speed up to 30x to turn longer activities into shareable moments.

Use this chart to estimate the length of your videos. For example, recording at 2x speed for 1 minute will give you about 30 seconds of TimeWarp video. Recording at 2x speed for 4 minutes will give you approximately 2 minutes of TimeWarp video.

In HERO mode, you can select Auto to let your GoPro automatically set the speed for you. HERO mode also lets you tap  to dramatically slow down your footage to real time, and then tap the button again to speed it back up.

Setting	Recording Time	Video Length
2x	1 minute	30 seconds
5x	1 minute	10 seconds
10x	5 minutes	30 seconds
15x	5 minutes	20 seconds
30x	5 minutes	10 seconds

Heads Up: Recording times are approximate. The video length may vary depending on the movement in your shot.

Tech Specs: Time Lapse

Setting	Examples
2x–5x	Driving through a scenic route
10x	Hiking and exploring
15x–30x	Running and mountain biking

PRO TIP: For the best results, try speeds 10x and up when shooting footage that may get bumpy.

TIME LAPSE INTERVAL

The interval sets how often your camera takes a shot in Time Lapse Video and Time Lapse Photo modes.

Available intervals are 0.5 (default), 1, 2, 5, 10, and 30 seconds; 1, 2, 5, and 30 minutes; and 1 hour.

Setting	Examples
0.5–2 seconds	Surfing, biking, or other sports
2 seconds	Busy street corner
5–10 seconds	Clouds or outdoor scenes for long durations
10 seconds–1 minute	Art projects or other lengthy activities
1 minute–1 hour	Construction work or other activities that take place over an very long period of time

Tech Specs: Time Lapse

Time Lapse Video Recording Time

Use this chart to determine the length of your videos. For example, recording for 5 minutes with a 0.5-second interval will give you 20 seconds of time lapse video. Recording for 15 minutes will give you 1 minute of video.

Setting	Recording Time	Video Length
0.5 second	5 minutes	20 seconds
1 second	5 minutes	10 seconds
2 seconds	10 minutes	10 seconds
5 seconds	1 hour	20 seconds
10 seconds	1 hour	10 seconds
30 seconds	5 hours	20 seconds
1 minute	5 hours	10 seconds
2 minutes	5 hours	5 seconds
5 minutes	10 hours	4 seconds
30 minutes	1 week	10 seconds
1 hour	1 week	5 seconds

PRO TIP: For the best results, mount your camera on a tripod or place it on a stable surface where it won't wobble or shake. Use TimeWarp video to capture time lapse video when you're on the move.

To learn more, see [TimeWarp Video Speed](#) (page 98).

Tech Specs: Protune

PROTUNE

Protune unlocks your camera's full creative potential by giving you manual control of Color, White Balance, Shutter Speed, and more. It's compatible with professional color correction tools and other editing software.

Here are some things to keep in mind:

- Protune is available as an advanced setting for selected modes. Scroll down in the settings menu to see all of the Protune settings.
- Some Protune settings are not available when you use Exposure Control.
- Changes to Protune settings in one capture mode apply only to that capture mode. For example, changing the White Balance in Video mode does not affect White Balance for Photo mode.

PRO TIP: You can restore all Protune settings to their defaults by tapping  in the settings menu.

Tech Specs: Protune

BIT RATE (HERO MODE)

Bit Rate determines the amount of data used to record a second of video. MAX lets you choose between high or low.

Setting	Description
Low (default)	Use a lower bit rate to minimize file sizes.
High	Use higher bit rates up to 78Mbps for optimal image quality.

Tech Specs: Protune

COLOR

Color lets you adjust the color profile of your videos or photos. Scroll between the options on the right side of the Color screen to see a live preview of each setting, and then tap the one you want.

Setting	Description
GoPro Color (default)	Provides GoPro color-corrected profile (same great color as when Protune is turned off).
Flat	Provides neutral color profile that can be color-corrected to better match footage captured with other equipment, offering more flexibility in post-production. Due to its long curve, Flat captures more details in shadows and highlights.

WHITE BALANCE

White Balance lets you adjust the color temperature of videos and photos to optimize for cool or warm lighting conditions. Scroll between the options on the right side of the White Balance screen to see a live preview of each setting, and then tap the one you want.

Options for this setting are Auto (default), 2300K, 2800K, 3200K, 4000K, 4500K, 5500K, 6000K, 6500K, and Native. Lower values will give you warmer tones.

You can also choose Native to create a minimally color-corrected file that allows for more precise adjustments in post-production.

Tech Specs: Protune

EXPOSURE VALUE COMPENSATION (EV COMP)

Exposure Value Compensation affects the brightness of your videos and photos. Adjusting this setting can improve image quality when shooting scenes with sharply contrasting lighting conditions.

Options for this setting range from -2.0 to +2.0. The default setting is 0.

Scroll between the options to see a live preview of each setting, and then tap the one you want. Higher values result in brighter images.

Heads Up: For Video, this setting is available only if Shutter is set to Auto.

You can also adjust the exposure based on a certain area of your scene.

To learn more, see [Exposure Control](#) (page 48).

PRO TIP: EV Comp adjusts brightness within the existing ISO setting. If brightness has already reached the ISO setting in a low-light environment, increasing the EV Com does not have any effect. To continue increasing the brightness, select a higher ISO value.

Tech Specs: Protune

SHARPNESS

Sharpness controls the quality of details captured in your video footage or photos. Options for this setting are High (default), Medium, and Low.

Scroll between the options to see a live preview of each setting, and then tap the one you want.

PRO TIP: If you plan to increase sharpness during editing, select Low for this setting.

Tech Specs: Protune

RAW AUDIO (HERO MODE)

This setting creates a separate .wav file for your video, in addition to the standard .mp4 audio track. You can select the level of processing to apply to the RAW audio track.

Setting	Description
Off (default)	No separate .wav file is created.
Low	Applies minimal processing. Ideal if you want to apply audio processing in post-production.
Med	Applies moderate processing based on the Wind-Noise Reduction setting. Ideal if you want to apply your own gain.
High	Applies full audio processing (automatic gain and Wind-Noise Reduction). Ideal if you want processed audio without AAC encoding.

Insert your SD card into a card reader to access the .wav files with your computer. They're saved with the same name and in the same location as the .mp4 files.

Tech Specs: Protune

MICROPHONES (HERO MODE)

Your camera's Microphone settings give you unprecedented versatility, especially if you're a vlogger. You can choose from four settings that prioritize sound coming from either side of the camera based on which lens is being used.

Setting	Description
Stereo (default)	Uses audio from all six microphones to record in stereo. Great for all-purpose recording.
Front	Prioritizes recording audio coming from the front of the camera (non-touch screen side) regardless of which lens is being used. Great when you're out exploring and describing the scene in front of you.
Back	Prioritizes recording audio coming from the back of the camera (touch screen side) regardless of which lens is being used. Great for selfies and reaction shots.
Match Lens	Record audio in sync with the side of the camera being used. Great if you frequently switch between recording with the front and back lens.

Heads Up: Wind-Noise Reduction is prioritized over the microphone settings. Turn Wind-Noise Reduction off if you want to be sure that your GoPro is recording with the microphone setting that you want.

To learn more, see [Wind-Noise Reduction](#) (page 111).

Tech Specs: Protune

360 AUDIO (360 MODE)

MAX uses its six microphones to deliver spherical surround sound not only from in front of and behind the camera, but also above and below it. The result is amazing audio that's just as immersive as the footage itself.

Setting	Description
360 + Stereo (default)	Record simultaneously in omni-directional and stereo sound.
Stereo	Record only in stereo.

Heads Up: Wind-Noise Reduction is prioritized over the 360 audio settings. Turn Wind-Noise Reduction off if you want to be sure that your GoPro is recording with the audio setting that you want.

To learn more, see [Wind-Noise Reduction](#) (page 111).

Tech Specs: Protune

WIND-NOISE REDUCTION

Your GoPro uses six microphones to capture sound while recording video. You can customize how they're used based on conditions where you're shooting and the type of sound you want in your finished video.

Setting	Description
Auto (default)	Automatically filters out excessive wind (and water) noise.
On	Use to filter out excessive wind noise or when our GoPro is mounted on a moving vehicle.
Off	Use when wind will not affect sound quality and you want to ensure that your GoPro is recording in stereo.

Heads Up: Wind-Noise Reduction is prioritized over your camera's other audio settings.

To learn more, see:

- [Microphones](#) (page 109)
- [360 Audio](#) (page 110)

Customer Support

GoPro is dedicated to providing the best possible service. To reach GoPro Customer Support, visit gopro.com/help.

Trademarks

GoPro, HERO and their respective logos are trademarks or registered trademarks of GoPro, Inc. in the United States and other countries. © 2021 GoPro, Inc. All rights reserved. For patent information, visit gopro.com/patents. GoPro, Inc., 3025 Clearview Way, San Mateo CA 94402 | GoPro GmbH, Floessergasse 2, 81369 Munich, Germany

Regulatory Information

For more information about country certification, please refer to the Important Product + Safety Instructions included with your camera or visit gopro.com/help.

